

CONNETTORI MASCHIO

PER CIRCUITO STAMPATO PASSO 5 mm

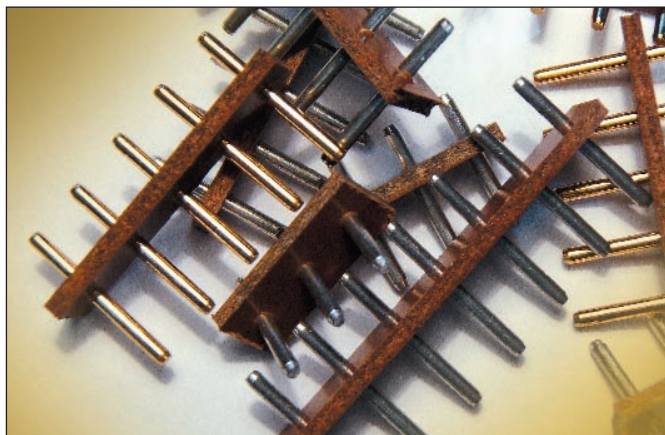

CONNETTORI MASCHIO CORTI / MALE SHORT CONNECTORS

MA/2MB

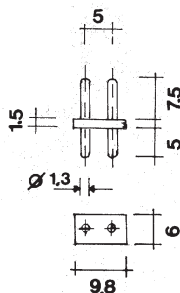

MA/6MB

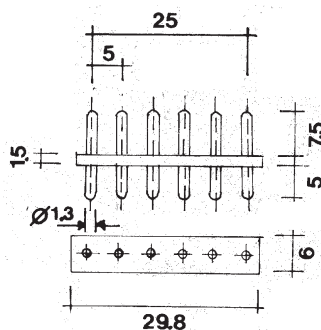

MA/3MB

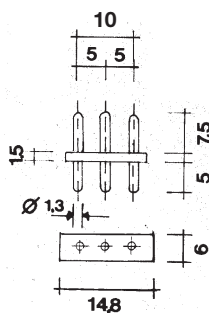

MA/7MB

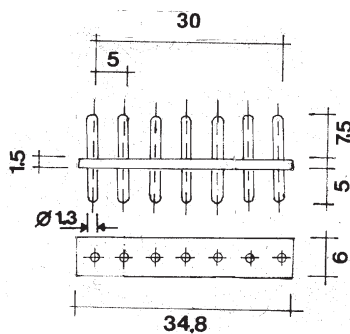

MA/5MB

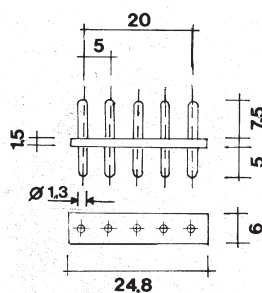

MATERIALI CON TOLLERANZE COMMERCIALI - CORPO ISOLANTE IN LAMINATO FENOLICO - CONTATTI IN OTTONE STAGNATO
 MATERIALS WITH STANDARD MARKET TOLERANCES - PHENOL-LAMINATED INSULATING BODY - TIN-PLATED BRASS CONTACTS

CONNETTORI LUNGI / LONG CONNECTORS

MA/3MA

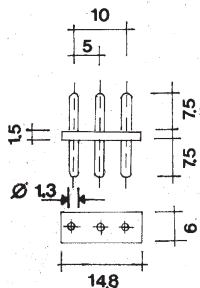

MA/5MA

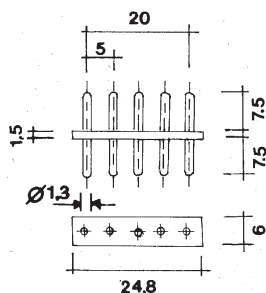

MA/7MA

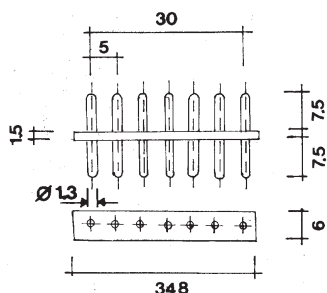

CONNETTORI EXTRACORTI / EXTRA-SHORT CONNECTORS

MA/2MC

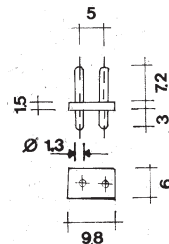

MA/3MC

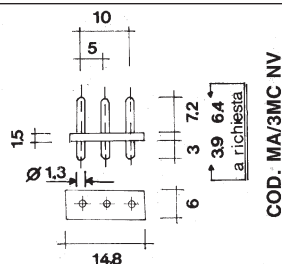

COD. MA/3MC NV

MA/5MC

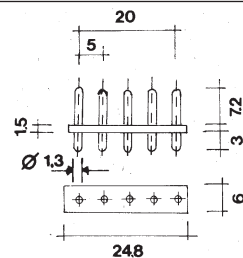

MA/6MC

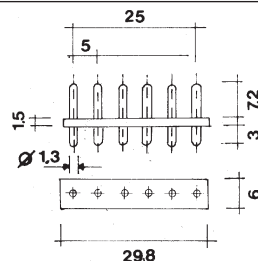

MA/7MC

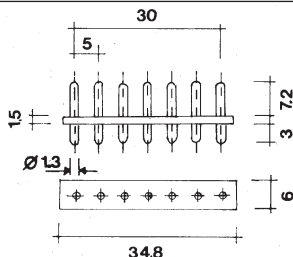

MATERIALI CON TOLLERANZE COMMERCIALI
CORPO ISOLANTE IN LAMINATO FENOLICO
CONTATTI IN OTTONE STAGNATO

MATERIALS WITH STANDARD MARKET TOLERANCES
PHENOL-LAMINATED INSULATING BODY
TIN-PLATED BRASS CONTACTS

MATERIALI CON TOLLERANZE COMMERCIALI
CORPO ISOLANTE IN LAMINATO FENOLICO
CONTATTI IN OTTONE STAGNATO

MATERIALS WITH STANDARD MARKET TOLERANCES
PHENOL-LAMINATED INSULATING BODY
TIN-PLATED BRASS CONTACTS

CONNETTORI FEMMINA

PER CIRCUITO STAMPATO PASSO 5 mm

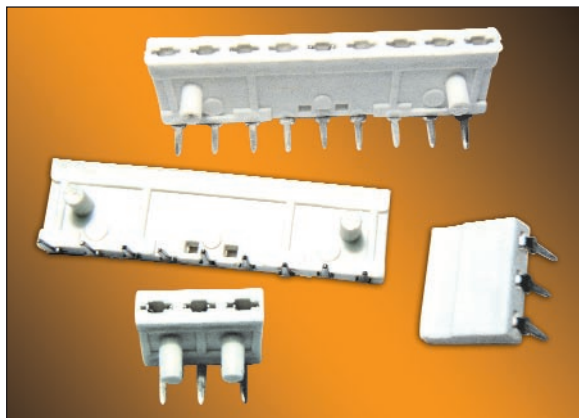

CONNETTORI FEMMINA PER CIRCUITO STAMPATO PASSO 5 mm / FEMALE CONNECTORS FOR PRINTED CIRCUITS PITCH 5 mm

<p>MA/9FA (per C.S.)</p> <p>44.8 3.5 4.45 1.25±1.40 5 2.8 6.5</p>	<p>MA/7FA (per C.S.)</p> <p>34.8 2.5 1.25±1.40 6.5</p>	<p>MA/5FA (per C.S.)</p> <p>24.8 1.5 1.25±1.40 6.5</p>
<p>MA/3FA (per C.S.)</p> <p>14.8 7.5 1.25±1.40 6.5</p>	<p>CMA/9FB (a saldare)</p> <p>44.8 3.5 4.45 1.25±1.40 5 2.8 6.5</p>	
<p>MA/7FB (a saldare)</p> <p>34.8 2.5 1.25±1.40 6.5</p>	<p>MA/5FB (a saldare)</p> <p>24.8 1.5 1.25±1.40 6.5</p>	<p>MA/3FB (a saldare)</p> <p>14.8 7.5 1.25±1.40 6.5</p>

CORPO ISOLANTE: NYLON / CONTATTI: OTTONE STAGNATO
INSULATING HOUSING: NYLON / CONTACTS: TIN-PLATED BRASS

CONNETTORI MASCHIO

PER CIRCUITO STAMPATO

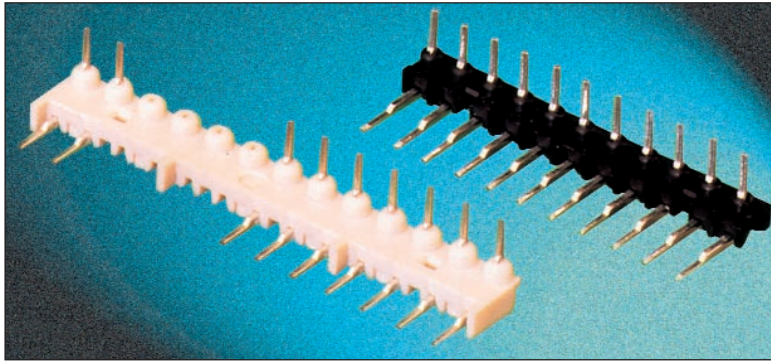

CONNETTORI MASCHIO PASSO 4,45 / MALE CONNECTORS PITCH 4,45

<p>430.080</p>	<p>430.081</p>
<p>430.082</p>	<p>430.083</p>
<p>430.084</p>	<p>430.085</p>

CONNETTORI MASCHIO PASSO 4 / MALE CONNECTORS PITCH 4

<p>430.089</p>	<p>430.090</p>
<p>430.091</p>	

CORPO ISOLANTE: NYLON AUTOESTINGUENTE / CONTATTI: FERRO STAGNATO
 INSULATING HOUSING: NYLON SELF-EXTINGUISHING / CONTACTS: TIN-PLATED METAL